

# Barefoot and Wetside

SAFETY MATTING



[www.plastexmatting.com](http://www.plastexmatting.com)



## Our Mission *A Mat for All Reasons*

Our mission is to add to our distributors, and in turn their customers, profitability, safety, productivity and style by designing and manufacturing cutting edge matting for all work, education and leisure environments.

### *Our Values*

Plastic Extruders Ltd (Plastex) are a second generation family run firm with long serving employees who take personal responsibility for maintaining the highest service standards and delivering the right solution on time and on budget.

### *Working with you to meet your needs*

Through our design and innovation programme we work with our customers to constantly improve the form, function and cost effectiveness of our products.

So, though we have an extensive range suitable for most applications, we often fulfill individual customer needs by producing bespoke solutions. If you feel you may have one we would be pleased to hear from you.



PETER O'SULLIVAN Sales Director      DAVID O'SULLIVAN Managing Director

Plastic Extruders Ltd UK & Plastex Matting Inc USA





## Plastex and the environment

As a global supplier with manufacturing plants in the UK and the USA, we constantly seek to reduce the environmental impact of our manufacturing processes. For example all our black matting is made with up to 100% post-industrial recycled material, but always with a minimum content of 30%.



To further minimise impact and avoid waste, we don't throw away any materials. All our factory trimmings and production process scrap are re-used in our own production. We do not re-sell any material to 3rd party reproprocessors.

### *R.E.A.C.H - Registration, Evaluation, Authorisation and Restriction of Chemical Substances*

The European Community R.E.A.C.H regulation (2007) gives manufacturers the responsibility of providing high level human and environmental protection from the use of chemicals in manufacturing.

Plastex does not use any substances currently included on the SVHC (Substances of Very High Concern) list under R.E.A.C.H, including "DEHP" Di(2-ethylhexyl) phthalate, also known as Di-octyl phthalate (DOP), plasticiser.

Further information can be found at [www.plastexmatting.com](http://www.plastexmatting.com).

Matting & flooring  
manufactured in Europe  
and the USA.

- distributed worldwide



















# Which Plastex product is right for you?

The chart below will help you choose the right mat for the right reasons, but if you have any questions contact us - we'll be delighted to help.

## Plastex matting provides:

- Hygiene - sanitized for extra protection
- Safety - a combination of high anti-slip and excellent drainage
- Barefoot comfort - specially designed to be soft enough for comfort and yet hard wearing

PRODUCT	SLIP RESISTANCE	BARE FEET	HYGIENIC	DRAINAGE/ SPILLAGE	WARMTH & COMFORT	USAGE
<b>WET AREA SAFETY MATTING</b>						
<b>Heronrib</b> p4-5						For poolside or changing room where barefoot traffic is extensive
<b>Floorline</b> p6						For drier walkways or areas in exercise facilities
<b>HeronTile</b> p7						Tile format for larger areas inside

<b>FOR DRY EXERCISE, GYM OR CRÈCHE ENVIRONMENTS</b>						
<b>HeronTred</b> p8-9				Dry only		Provides a cushioning and noise reducing coverage

## Why sports & leisure matting?

### Keeping fit may be unhealthy/risky underfoot.

The poolside and changing room with their combination of bare feet and water, can be an accident waiting to happen; and that's before you think about fungal infection and comfort.



Hygiene, safety & comfort - inside or out  
*A mat for all reasons*

# HERONRIB

Warm, comfortable, self draining safety matting



Heronrib is the ultimate sports and leisure matting system for use in wet areas where barefoot traffic is extensive. Exceptionally warm and comfortable to stand on, Heronrib has a specially embossed slip resistant surface and Sanitized additives for assured underfoot hygiene in areas where bacteria tends to harbour.

Made from strong, non-porous PVC sections with channelled underbars, Heronrib will automatically self-drain even the largest amounts of water. It is therefore not only perfect for preventing a splash but also for making a splash of colour around swimming pools, saunas and Jacuzzis using one or more of Heronrib's eye-catching colours.

## Standard colours



OXFORD BLUE



OCEAN BLUE

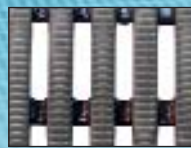

CHARCOAL GREY



FOREST GREEN



MULBERRY RED

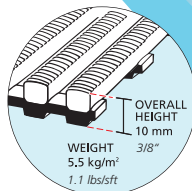

PRODUCT	HEIGHT mm (in)	LENGTH m (ft)	WIDTH OPTIONS cm (ft)		
Heronrib - UK	10	10	50	100	122
Heronrib - USA	3/8"	33' or 40'	2'	3'	4'

Product Code H2K



Sanitized® additives  
Anti-bacterial & Anti-fungal



For ancillary range  
see page 10

A permanent and effective barefoot wet area solution that is easy to clean and maintain whether used indoors or outdoors.

◆ Barefoot comfort & safety

◆ Effective inside or out

◆ Sanitized anti-bacterial and anti-fungal additives

◆ Slip resistant with instant drainage

◆ Loose lay yet stable underfoot

THE MAIN BENEFITS



# FLOORLINE

For light duty and domestic wet side areas

Floorline provides an economical alternative for lighter duty applications where slip resistance is required outdoors or in.

The open grid slip resistant surface provides effective safety underfoot in light traffic changing areas and swimming pool surrounds. Supplied in roll format, Floorline is loose laid and a great formula that not only enhances, but provides a safer and cooler footing.

◆ Slip resistant cushioned surface

◆ Open grid roll format

◆ Loose lay - lighter weight construction

◆ Effective indoors and out

◆ Economical alternative

## THE MAIN BENEFITS

### Standard colours



RED



BLUE

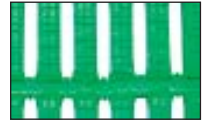

GREEN



BEIGE



WHITE

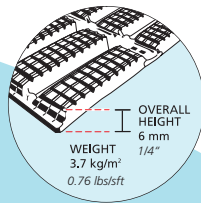

PRODUCT	HEIGHT mm (in)	LENGTH m (ft)	WIDTH OPTIONS cm (ft)	
Floorline	6 (1/4")	10 (33')	60 (2')	91 (3')

Product Code FLN



# HERONTILE

## Barefoot wet area tiling

The Herontile system has a simple click together joining mechanism designed to cover large floor areas seamlessly and easily. It provides a hygienic, safe and attractive surface with permanent anti-fungal and anti-bacterial Sanitized additives.

Herontile is made from an Ethylene Vinyl Acetate (EVA) composition to guarantee softness and comfort. It also has a circular surface embossing for enhanced slip resistance and stands 15mm high on strong support legs so that water disperses well underneath.

Four bright, stable and appealing colour options are complementary to interior schemes.

- ◆ Slip resistance
- ◆ Warm & hygienic
- ◆ Inside use only
- ◆ Barefoot comfort
- ◆ Easy fit, click together tile system

THE MAIN BENEFITS

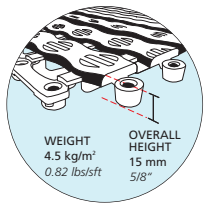

PRODUCT	HEIGHT mm (in)	SIZE cm (ft)	QUANTITY
Herontile	15 (5/8")	33 x 33 (13" x 13") tiles	27 tiles per box

Product Code HRT

### Standard colours



OCEAN BLUE



LIGHT BLUE



LIGHT GREY



BEIGE



Sanitized® additives  
Anti-bacterial & Anti-fungal



For ancillary range  
see page 10

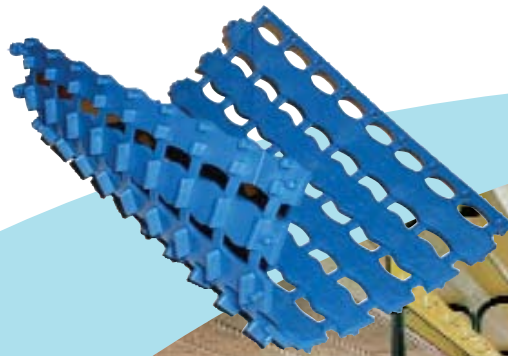

## Push together rubber floor tile covering



Impact absorbing and insulating, Herontred vulcanised rubber tiles interlock together covering large areas of cold, hard floors in simply no time at all. Available in an attractive, dimpled or a marbled finish and a bright range of colours. Herontred will not only look good, but will also cushion solid surfaces and protect existing floor coverings, whilst providing a safe, warm and smooth covering for sports and play.

Ideal in crèches, nurseries or exercise areas providing a cushioning and effective one piece flooring.

It is recommended to avoid light colours in heavy traffic areas.

### Standard colours

#### Dimpled surface

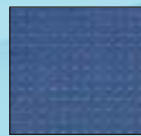

OCEAN BLUE 7

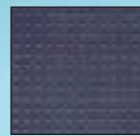

OXFORD BLUE 45

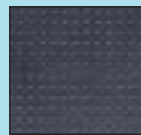

BLACK 50

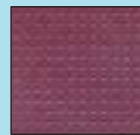

MULBERRY RED 74



HOLLY GREEN 71



PLUM RED 62



ORANGE 49

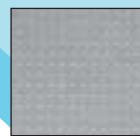

LIGHT GREY 58

### Standard colours

#### Marbled surface



AZUL 200



CELESTE 210

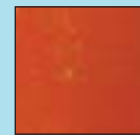

NARANJA 260



GRIS 220

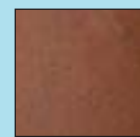

MARRON 240



HAYA 230

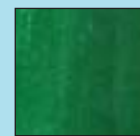

MENTA 250

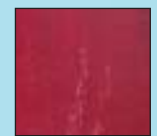

ROJO 270

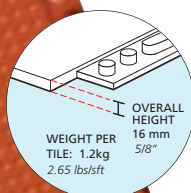

PRODUCT	HEIGHT mm (in)	SIZE cm (ft)	QUANTITY/DESCRIPTION
Herontred Tile	16 (5/8")	35 x 35 (1'2" x 1'2")	9 tiles per pack

Other colours available on request, due to limitations of the printing process, actual colours shown may vary.

Product Code HTD



For ancillary range  
see page 10

It is certified fire resistant and will reduce noise dramatically. Bevelled edges and skirting also protect and help prevent trips.



- ◆ Impact absorbent
- ◆ Excellent noise reduction
- ◆ Quick and easy installation
- ◆ Slip resistant and insulating
- ◆ Certified fire resistance

THE MAIN BENEFITS

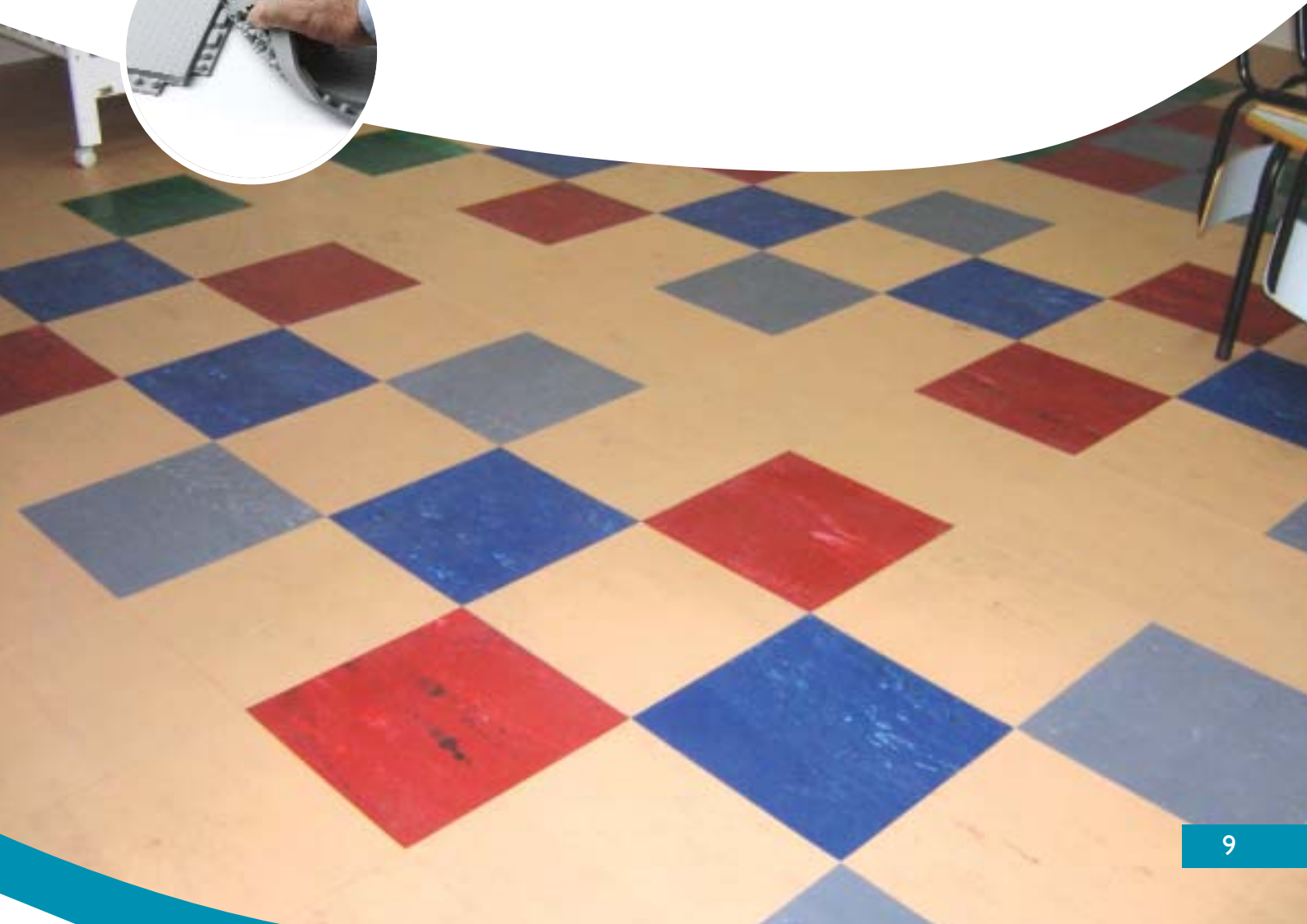

# Sports & leisure matting and tiling ancillaries

To make our sports and leisure functional and stylish we provide a full range of edging and fitting ancillaries.

HERONRIB

### EDGING STRIP

Flexible PVC edging roll

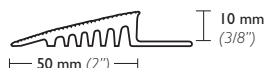

50mm (2") x 10.1m (33') length with welding paste

Colours:  
 Dark Grey *EDGE/LPG*  
 Black *EDGE/LPB*

2 rolls per pack

### CONNECTOR CLIPS

For joining sections of matting together

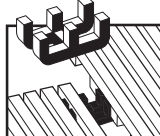

Dual Purpose

Supplied in packs of 10

*CCDP*

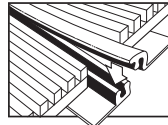

Snap Track 2 part strip

Supplied with welding paste

Colour: Dark Grey

Low Profile 1.8m (5'11") *ST/LP*

HERONTILE

### EDGING RAMP

When the tiles meet an open space a ramp can be attached to create a safe and attractive transition from the floor surface to the Herontile.

Colours:  
 Ocean Blue *EDGE/HRT-BLU*  
 Dark Grey *EDGE/HRT-DGY*

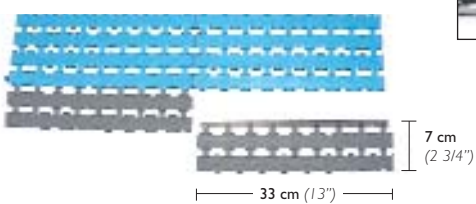
HERONTRED

### RAMPED EDGING



Type 1 - Female

Supplied in 35cm (1'2") lengths

Colours: Grey or Black

*EDGE/HT1*



Type 2 - Male

Supplied in 35cm (1'2") lengths

Colours: Grey or Black

*EDGE/HT2*

### SKIRTING & CORNERS



Skirting Strip

Supplied per strip in 35cm (1'2") lengths



Grey or Black *SKT-STRIP*



External Corner  
Grey or Black  
*S1*



Internal Corner  
Grey or Black  
*S2*

Ancillary part ordering codes shown in italics. Power shears and secateurs are also available for cutting matting to size and shape. See price list separate for details.

# We make our matting, and that makes all the difference

When you buy Plastex matting you're also buying our extensive know-how that comes from over 45 years of designing, testing and manufacturing matting solutions for a diverse range of applications; knowledge we apply to make sure we find exactly the right solution for you.

This is important as an incorrectly specified product may actually increase risk. For example using a mat designed for bare feet in a workplace area could potentially increase slip accidents. That's why simply picking a product from a web page may not deliver the correct solution.

## Talk to Us

To make sure you get the right mat for the right reasons, talk to us and our distributors.

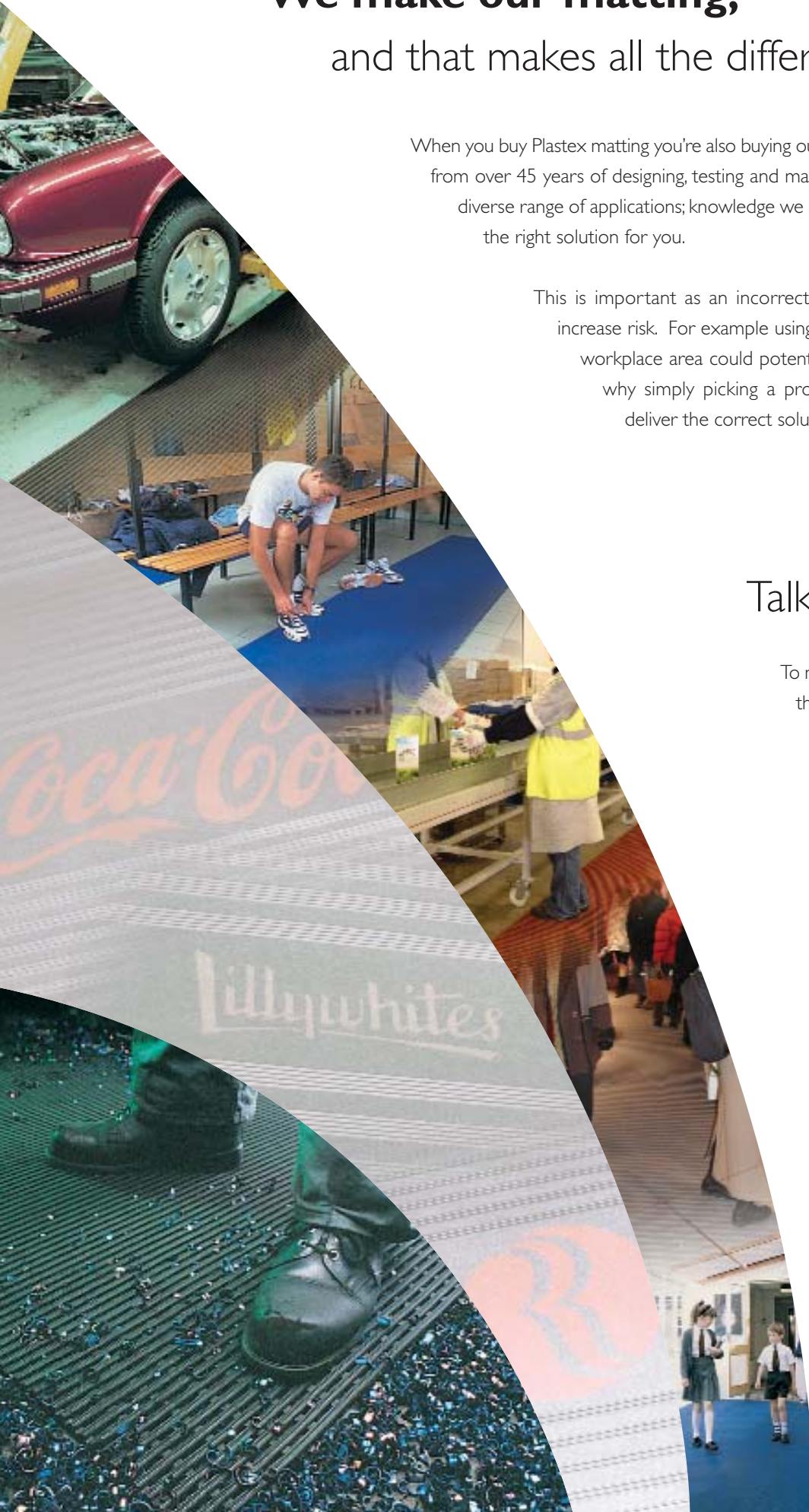

# Plastex

## Three levels of service

Once we've established your exact need, we'll recommend the product that is right for you, from our three levels of service.

### General Purpose

We have an extensive range of general purpose matting designed for various environments. So whether you're looking for comfort, slip resistance, soil removal or increased hygiene we'll have the product for you.

### Specialist

We have also built up a full range of products for demanding specialist environments such as light and heavy industrial, food preparation big and small.

### Bespoke

If we can't exactly meet your needs from our current range we'll design and manufacture a mat specifically for you.

Whatever your requirement we'll put all our knowledge and care into delivering exactly the mat you need, on time and on budget - *'a mat for all reasons'*.

## Testing and Measurement

In our constant pursuit of excellence, we subject our products to the rigors of scientific testing. This includes external testing through international bodies, but we don't stop there. If an external test doesn't exist, we will commission a university research project. Plastex continually strive to ensure we maintain the highest standards expected by our customers worldwide.

[www.plastexmatting.com](http://www.plastexmatting.com)



The 45+ products within the Plastex range of matting and flooring offer **"a mat for all reasons"**.

To make it easier for you to choose the right mat for the right reason, we've divided our range into the sections below. Simply pick the section that best suits your need, and then use the segmentation chart you'll find at the front of each section to help you make your final choice.

Section brochures available :-



Barefoot and Wetside	
SAFETY MATTING	
Product Index	
Floorline	6
Heronrib	4
Herontile	7
Heronred	8

Full manufacturer warranty - another good reason to choose Plastex

If you follow our simple fitting and maintenance instructions, all Plastex flooring and matting will give excellent and long service. But for extra peace of mind, and in the unlikely event of a Plastex product being faulty, we offer a full refund or replace warranty. The warranty periods vary depending on the product, you can find full terms and details at

[www.plastexmatting.com/matfax/doc.php?doc\\_id=167&action=inline](http://www.plastexmatting.com/matfax/doc.php?doc_id=167&action=inline)

# Ensure you have been supplied with a genuine Plastex product.

By choosing Plastex you're benefiting from our extensive know how that comes from over 45 years of designing, testing and making matting for an extensive range of customers and reasons.

Since July 2010, we have been embossing the trade marked names on the underside of our grid matting.

The programme began with Vynagrip and is being extended to include all dual layer grid rolls manufactured in the UK and USA. In addition to the roll out period, there will be a time lag in the supply chain, so if you have any doubt that you've been supplied a genuine Plastex mat, where you cannot see the trademark on the underside, ask your distributor to get us to confirm it.

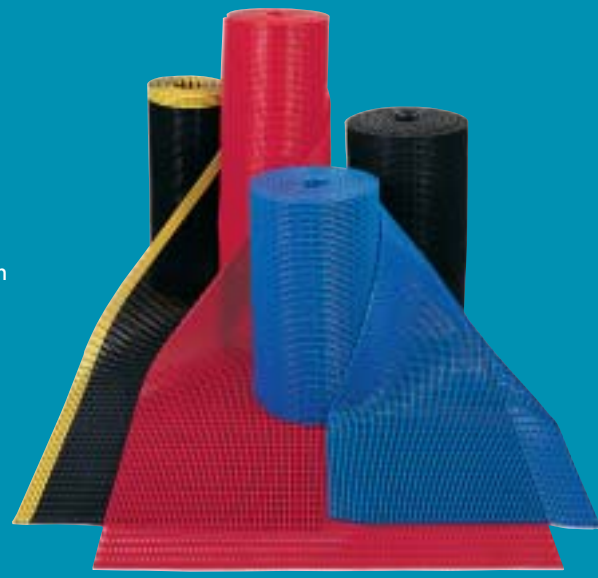

#### **Plastic Extruders Ltd.**

Russell Gardens, Wickford,  
Essex SS11 8DN, England  
Tel: 01268 571116 Fax: 01268 560027

[www.plastex.co.uk](http://www.plastex.co.uk)

#### **Plastex Matting Inc.**

120 55th Street NE,  
Fort Payne, AL 35967 USA  
Tel: 256 845 7725 Fax: 256 845 6786

[www.plastexmatting.com](http://www.plastexmatting.com)



THE SYMBOL OF EXCELLENCE